

1	1.875" OD Peak
2	1.625" OD Truss
3	1.625" OD Arc
4	1.625" OD Post
5	2"x4" Wood Framing
6	2"x12" Dual Sliding Door Header
7	2'x2' Hot Air Vent
8	6'x7' Bay Door
9	1"x4" Roll-Up Board
10	1.375" OD Purlin

WIND LOAD - 65 MPH
SNOW LOAD - 30 PSF

UNLESS OTHERWISE SPECIFIED, DIMENSIONS ARE IN INCHES .XX = ±.0- .XXX = ±.00- .XXXX = ±.000- SURFACE FINISH ✓ DO NOT SCALE DRAWING BREAK ALL SHARP EDGES AND REMOVE BURRS THIRD ANGLE PROJECTION		NAME Rica Abing	DATE 08/07/2024
ANGULAR = ± ° FRACTIONAL = ±		CHECKED Kevin Roberts	
		APPROVED	
MATERIAL Galvanized Steel		FINISH	

Roberts Ranch Hoophouses			
TITLE 16' Wide Gothic Hightunnel Front View			
SIZE A	DWG NO. G16-1	REV B	
SCALE 1:40	WEIGHT	SHEET 1 of 7	

B

A

B

A

2

1

2

1

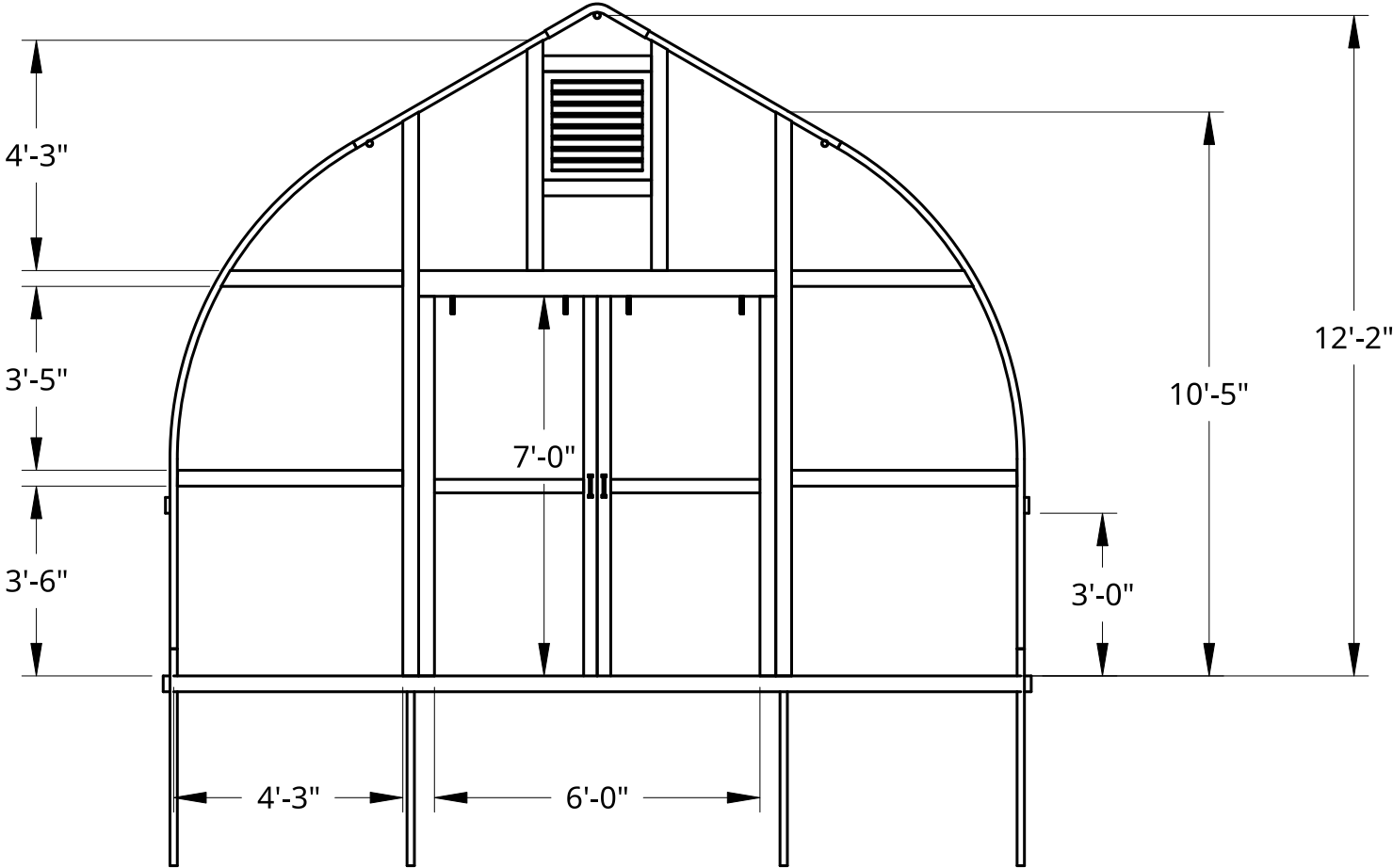

WIND LOAD - 65 MPH
 SNOW LOAD - 30 PSF

UNLESS OTHERWISE SPECIFIED, DIMENSIONS ARE IN INCHES .XX = ±.0- .XXX = ±.00- .XXXX = ±.000-		NAME	DATE	Roberts Ranch Hoophouses	
SURFACE FINISH ✓		DRAWN	Rica Abing	08/07/2024	TITLE 16' Wide Gothic Hightunnel Dimensional Front View
DO NOT SCALE DRAWING		CHECKED	Kevin Roberts		
BREAK ALL SHARP EDGES AND REMOVE BURRS		APPROVED			
THIRD ANGLE PROJECTION		MATERIAL	FINISH		SIZE A
		Galvanized Steel			DWG NO. G16-2
				SCALE 1:40	REV B
				WEIGHT	SHEET 2 of 7

2

1

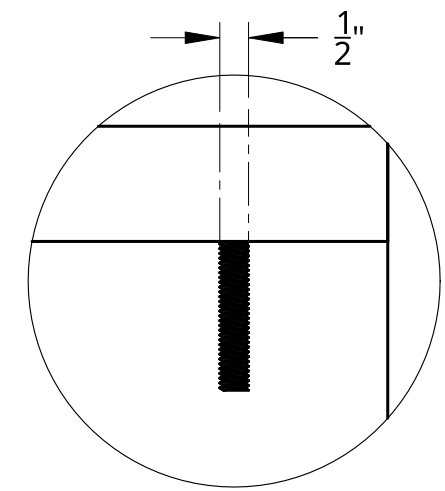
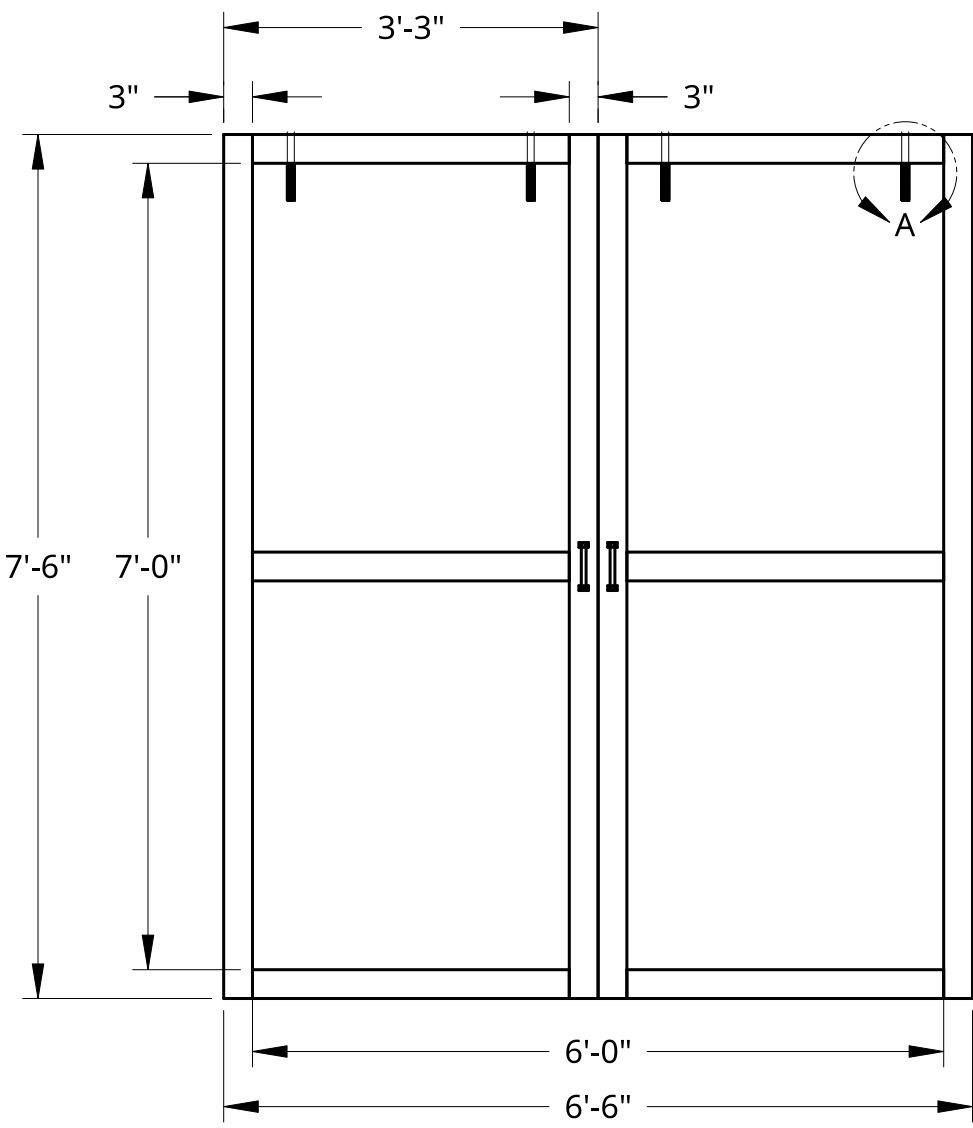

DETAIL A
1/2" Hole
SCALE 1:5

B

B

A

A

WIND LOAD - 65 MPH
SNOW LOAD - 30 PSF

UNLESS OTHERWISE SPECIFIED,
DIMENSIONS ARE IN INCHES

.XX = ±.0- ANGULAR = ± °
.XXX = ±.00- FRACTIONAL = ±
.XXXX = ±.000-

SURFACE FINISH

DO NOT SCALE DRAWING

BREAK ALL SHARP EDGES AND
REMOVE BURRS

THIRD ANGLE PROJECTION

	NAME	DATE
DRAWN	Rica Abing	08/07/2024
CHECKED	Kevin Roberts	
APPROVED		
MATERIAL	Galvanized Steel	
FINISH		

Roberts Ranch Hoophouses			
TITLE 6' x 7' Dual Bay Door Blow-Up Plan & Details			
SIZE A	DWG NO. G16-3	REV. A	
SCALE 1:40	WEIGHT	SHEET 3 of 7	

2

1

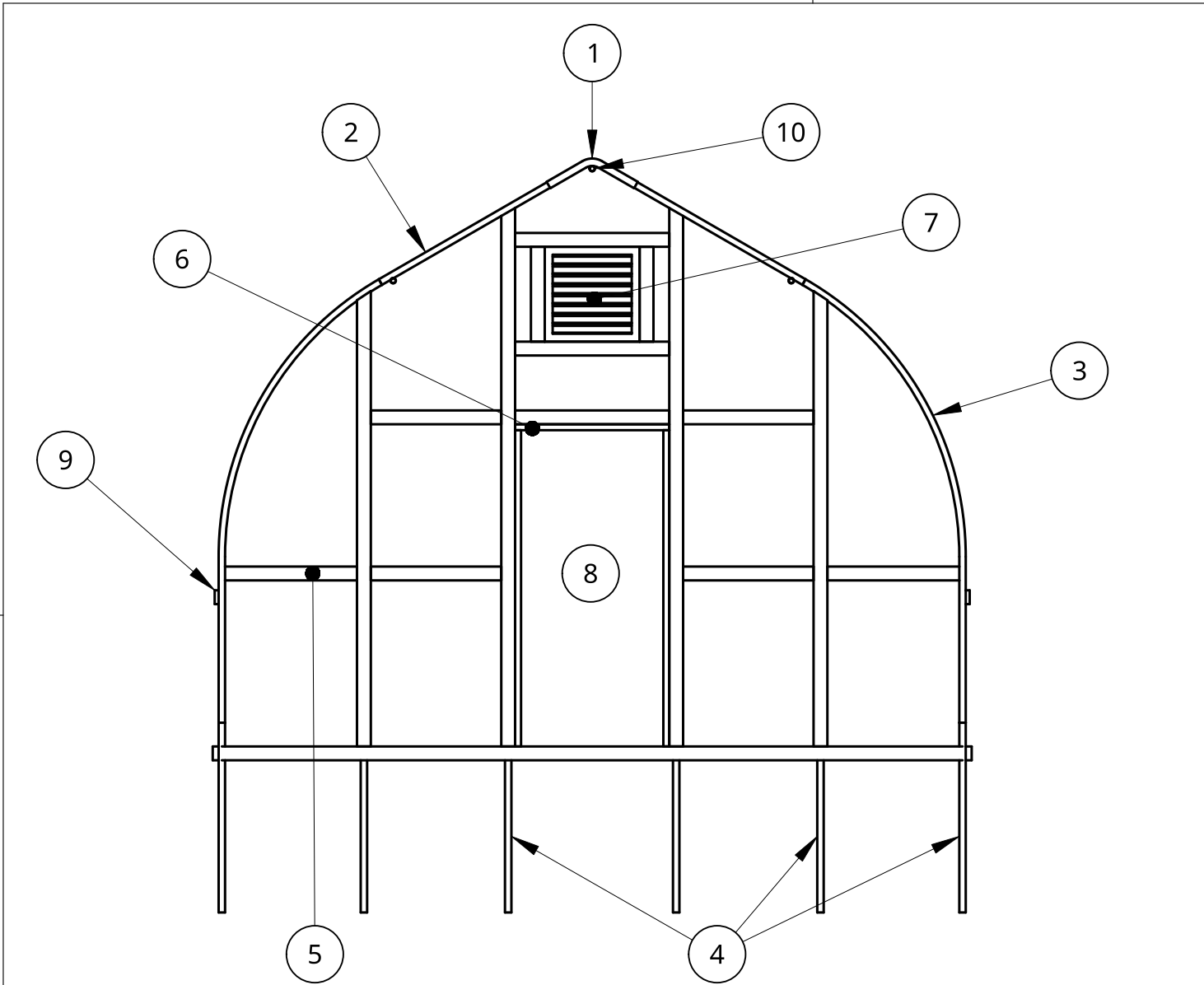

1	1.875" OD Peak
2	1.625" OD Truss
3	1.625" OD Arc
4	1.625" OD Post
5	2"x4" Wood Framing
6	2"x4" Door Framing
7	2'x2' Hot Air Vent
8	36"x80" Man Door
9	1"x4" Roll-Up Board
10	1.375" OD Purlin

WIND LOAD - 65 MPH
 SNOW LOAD - 30 PSF

UNLESS OTHERWISE SPECIFIED,
 DIMENSIONS ARE IN INCHES

.XX = ±.0-
 .XXX = ±.00-
 .XXXX = ±.000-

ANGULAR = ± °
 FRACTIONAL = ±

SURFACE FINISH

DO NOT SCALE DRAWING

BREAK ALL SHARP EDGES AND
 REMOVE BURRS

THIRD ANGLE PROJECTION

	NAME	DATE
DRAWN	Rica Abing	08/02/2024
CHECKED	Kevin Roberts	
APPROVED		
MATERIAL	Galvanized Steel	
FINISH		

Roberts Ranch Hoophouses			
TITLE 16' Wide Gothic Hightunnel Back View			
SIZE A	DWG NO. G16-4	REV B	
SCALE 1:40	WEIGHT	SHEET 4 of 7	

B

B

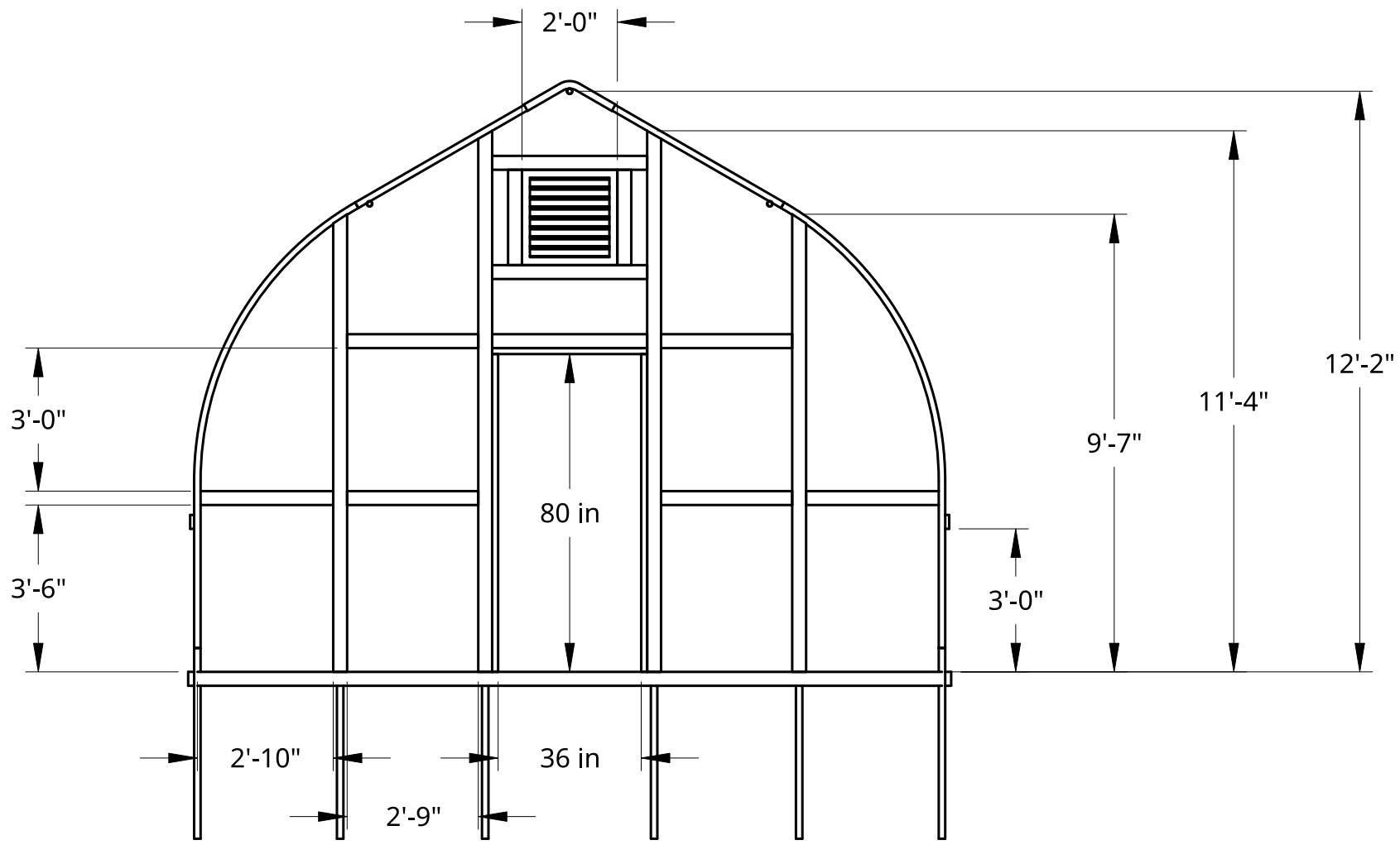

A

A

WIND LOAD - 65 MPH
 SNOW LOAD - 30 PSF

UNLESS OTHERWISE SPECIFIED, DIMENSIONS ARE IN INCHES .XX = ±.0- .XXX = ±.00- .XXXX = ±.000- SURFACE FINISH ✓ DO NOT SCALE DRAWING BREAK ALL SHARP EDGES AND REMOVE BURRS THIRD ANGLE PROJECTION			NAME	DATE	Roberts Ranch Hoophouses	
	DRAWN	Rica Abing	08/02/2024	TITLE		
	CHECKED	Kevin Roberts		16' Wide Gothic Hightunnel Dimensional Back View		
	APPROVED			SIZE	DWG. NO.	REV
				A	G16-5	B
	MATERIAL	FINISH	SCALE	WEIGHT	SHEET	
	Galvanized Steel		1:40		5 of 7	

2

1

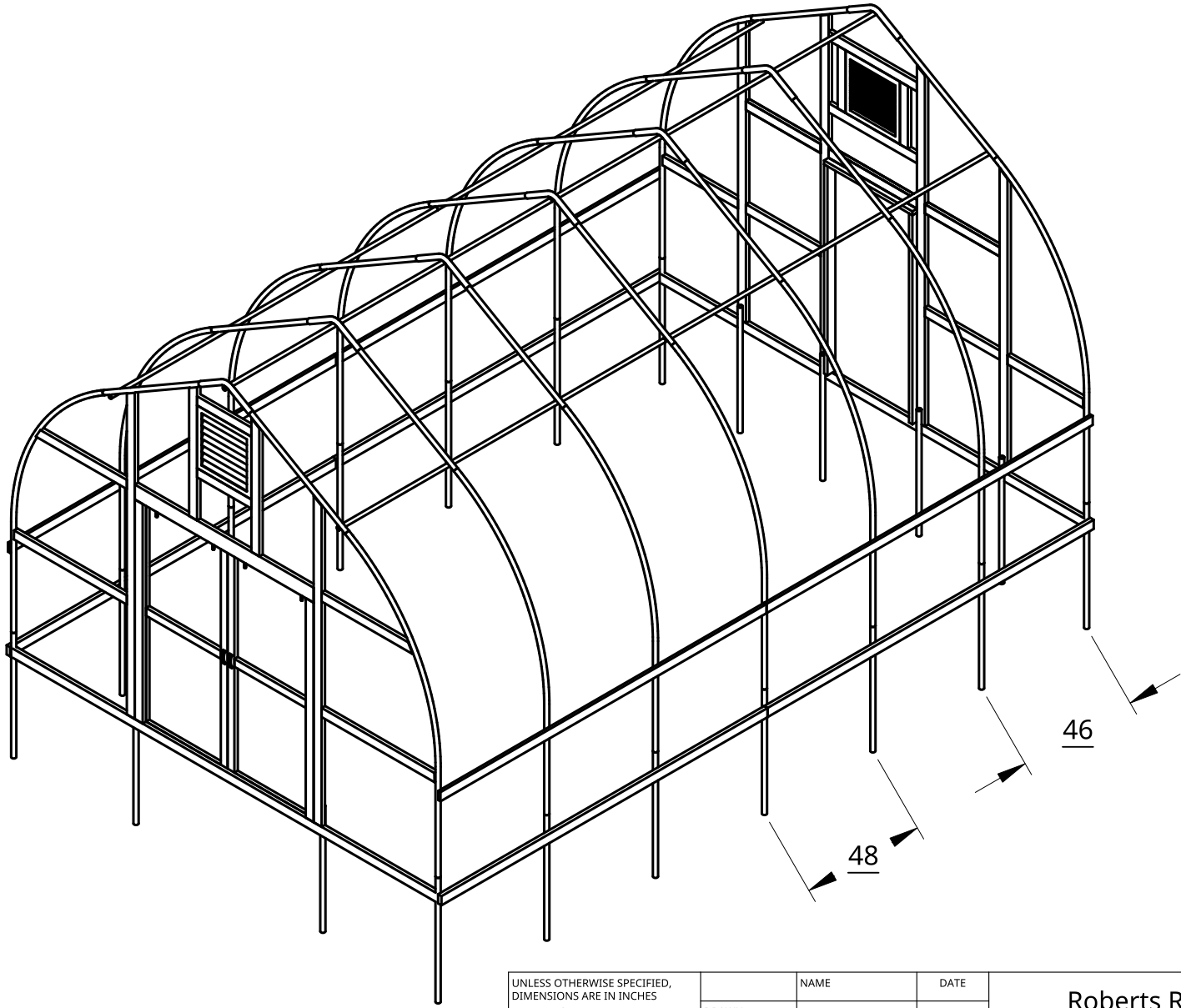

2

1

B

B

A

A

46

48

WIND LOAD - 65 MPH
SNOW LOAD - 30 PSF

UNLESS OTHERWISE SPECIFIED,
DIMENSIONS ARE IN INCHES
.XX = ±.0-
.XXX = ±.00-
.XXXX = ±.000-
SURFACE FINISH

DO NOT SCALE DRAWING
BREAK ALL SHARP EDGES AND
REMOVE BURRS

THIRD ANGLE PROJECTION

	NAME	DATE
DRAWN	Rica Abing	08/07/2024
CHECKED	Kevin Roberts	
APPROVED		

MATERIAL	FINISH
Galvanized Steel	

Roberts Ranch Hoophouses			
TITLE 16' Wide Gothic Hightunnel Isometric View & BOM			
SIZE A	DWG NO. G16-6	REV B	
SCALE 1:50	WEIGHT	SHEET 6 of 7	

2

1

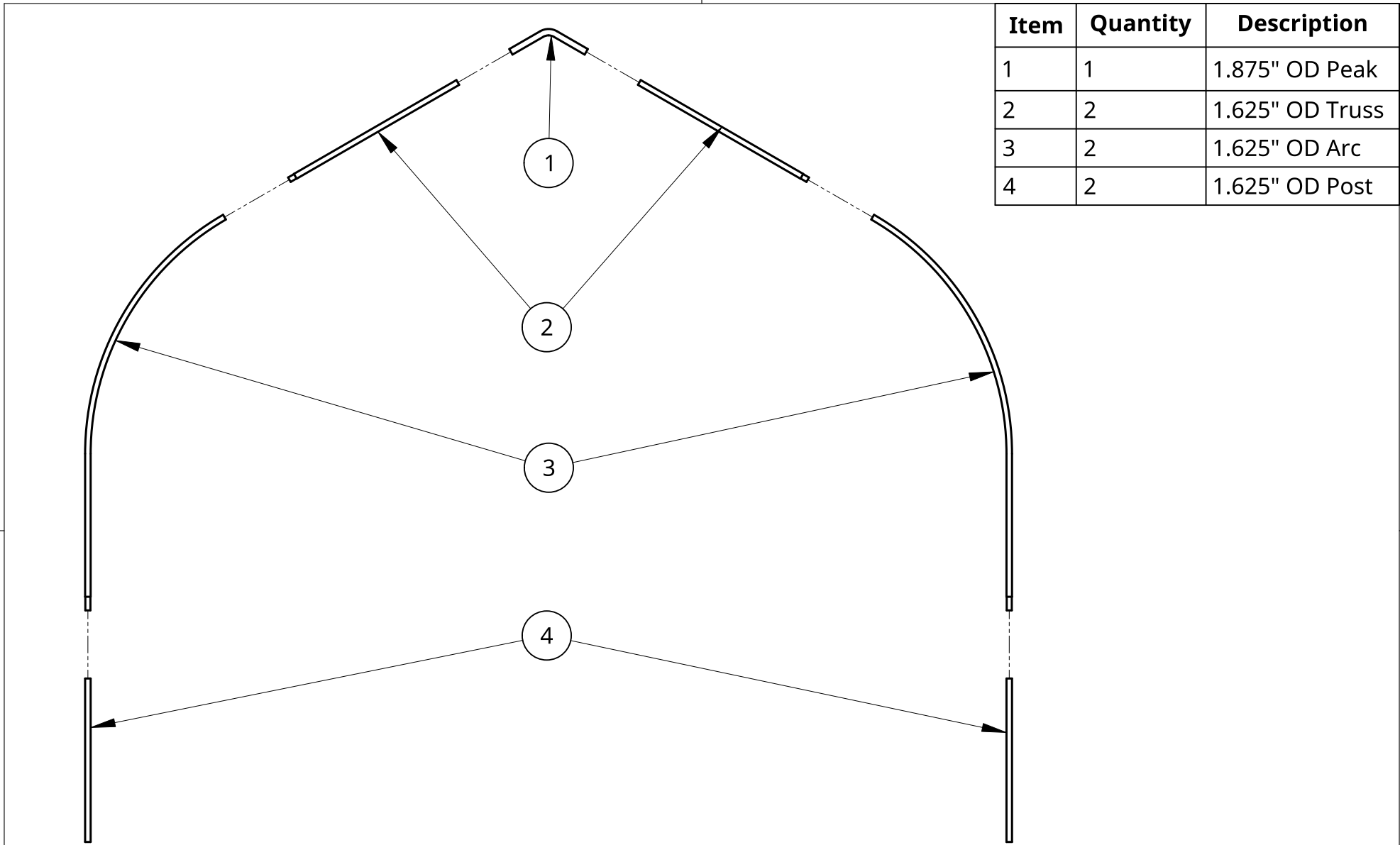

Item	Quantity	Description
1	1	1.875" OD Peak
2	2	1.625" OD Truss
3	2	1.625" OD Arc
4	2	1.625" OD Post

UNLESS OTHERWISE SPECIFIED,
DIMENSIONS ARE IN INCHES
.XX = ±.0-
.XXX = ±.00-
.XXXX = ±.000-
ANGULAR = ± °
FRACTIONAL = ±

SURFACE FINISH

DO NOT SCALE DRAWING

BREAK ALL SHARP EDGES AND
REMOVE BURRS

THIRD ANGLE PROJECTION

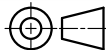

	NAME	DATE
DRAWN	Rica Abing	06/25/2024
CHECKED	Kevin Roberts	
APPROVED		

MATERIAL	FINISH
Galvanized Steel	

Roberts Ranch Hoophouses			
TITLE			
16' Wide Gothic Hightunnel Arch Exploded View			
SIZE	DWG NO.	REV	
A	G16-7	B	
SCALE	WEIGHT	SHEET	
1:50		7 of 7	

2

1

B

B

A

A